



Sea-Fire Europe 2025 Price List

Prices included effective January 1, 2025
Prices are subject to change with 30 day notice.

Prices are in Euro

This price list includes systems with CE approved cylinders.

Clouds International B.V.

Mail@clouds.nl

www.clouds.nl

0348-551644



Table of Contents

NFG Line FK-5-1-12 Non-Refillable Systems	
Automatic Only.....	3
Manual & Automatic.....	4
NMG Line - Manual Only FK-5-1-12 Non-Refillable Systems.....	5
NFD Line FK-5-1-12 Refillable Systems	
Automatic Only.....	6
Manual & Automatic.....	8
NMD Line - Manual Only FK-5-1-12 Refillable Systems.....	13
Replacement Bracket Assemblies.....	16
Manual Release Cable Kits.....	17
Manual Release Cable Accessories.....	19
NEW PRODUCT: AT Series Compact Aerosol Fire Suppression Systems.....	20
AT Series Cable Kits.....	21
Portable Fire Extinguishers & Fire Blankets.....	22
Electronics - Machinery Shutdown Restart Systems and Displays.....	24
Electronics - Legacy Engine Shutdown Restart System Displays.....	25
Electronics - Detectors & Alarms.....	26
Electronics - Audio/Visual Devices.....	27
Warranty Policy.....	28

CLOUDS INTERNATIONAL B.V.



NFG Line - Automatic Only FK-5-1-12 Non-Refillable Systems

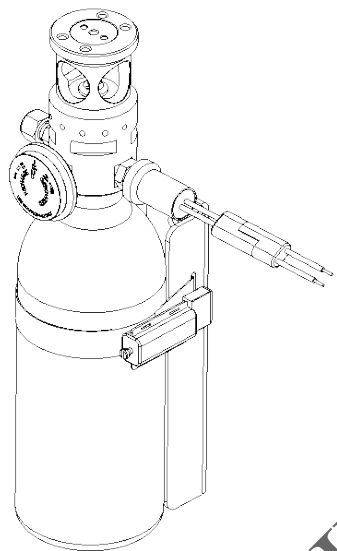

NFG 25 A

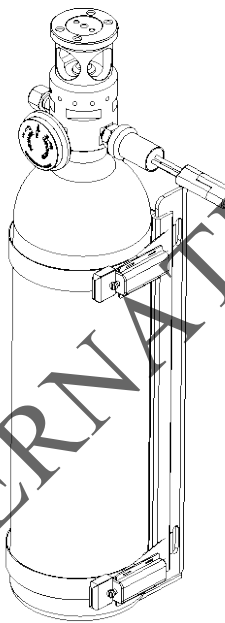

NFG 50-75 A

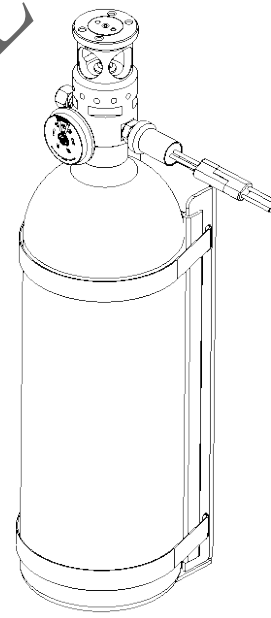

NFG 100 A

PN	Model	Datasheet	Volume of Protection	Install Dim.	Ship Weight	UPC Code	List Price- EUR
502-005	NFG 25 A	500-001	25ft ³ (0.7m ³)	5.0" X 11.4"	6.5 lb (2.9 kg)	791828147083	€ 381
502-053	NFG 50 A	500-025	50ft ³ (1.4m ³)	5.0" X 17.5"	10.0 lb (4.5 kg)	791828147564	€ 529
502-101	NFG 75 A	500-025	75ft ³ (2.1m ³)	5.0" X 17.5"	11.0 lb (5 kg)	791828148042	€ 625
502-149	NFG 100 A	500-049	100ft ³ (2.8m ³)	5.0" X 17.7"	13.5 lb (6.1 kg)	791828148523	€ 800

Part numbers listed above are standard configuration; Pressure switch contacts closed under pressure (in service), pressure switch connector - Delphi connector including mating plug with 6" leads, 12V DC light kit. Contact factory for Part # if other configuration is needed.



NFG Line - Manual & Automatic FK-5-1-12 Non-Refillable Systems

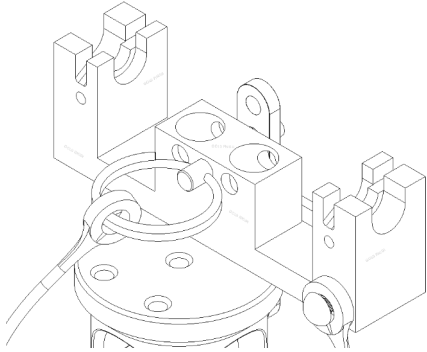

Manual/Automatic Systems require one of the following Bi-Directional discharge assemblies:

- 136-0xxx - Manual/Automatic
- 136-2xxx - Manual/Automatic with Fire Sleeve

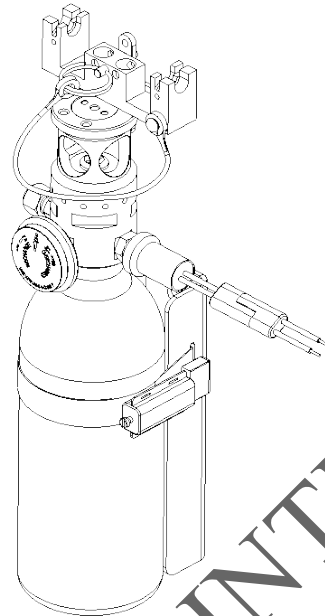

NFG 25 M

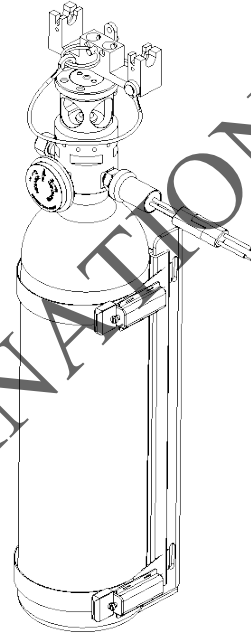

NFG 50-75 M

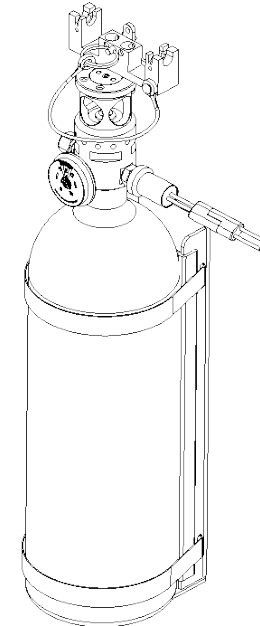

NFG 100 M

PN	Model	Datasheet	Volume of Protection	Install Dim.	Ship Weight	UPC Code	List Price- EUR
502-011	NFG 25 M	500-001	25ft ³ (0.7m ³)	5.0" X 12.7"	7.0 lb (3.2 kg)	791828147144	€ 471
502-059	NFG 50 M	500-025	50ft ³ (1.4m ³)	5.0" X 18.8"	10.0 lb (4.5 kg)	791828147625	€ 620
502-107	NFG 75 M	500-025	75ft ³ (2.1m ³)	5.0" X 18.8"	11.0 lb (5 kg)	791828148103	€ 716
502-155	NFG 100 M	500-049	100ft ³ (2.8m ³)	5.2" X 19.0"	13.5 lb (6.1 kg)	791828148585	€ 891

Part numbers listed above are standard configuration; Pressure switch contacts closed under pressure (in service), pressure switch connector - Delphi connector including mating plug with 6" leads, 12V DC light kit. Contact factory for Part # if other configuration is needed.



NMG Line - Manual Only FK-5-1-12 Non-Refillable Systems

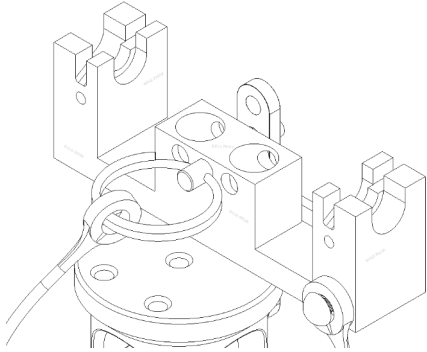

Manual Only Systems require one of the following Bi-Directional discharge assemblies:

- 136-5xxx - Manual Only*
- 136-6xxx - Manual Only with Fire Sleeve

*When 136-5xxx cables are used, an appropriate length of 138-2xxx Fire Sleeve must be installed over the cable within the protected space.

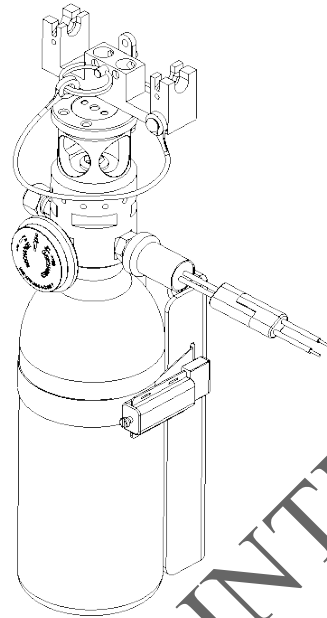

NMG 25

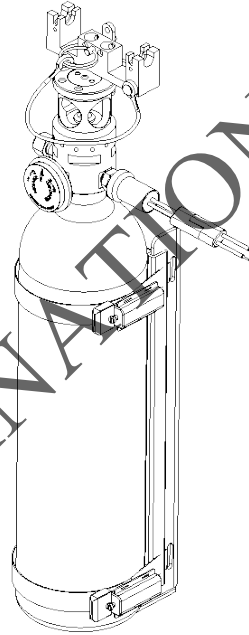

NMG 50-75

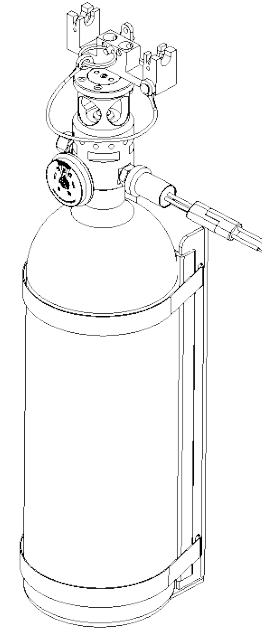

NMG 100

PN	Model	Datasheet	Volume of Protection	Install Dim.	Ship Weight	UPC Code	List Price- EUR
522-012	NMG 25	520-001	25 ft ³ (0.7 m ³)	5.0" X 12.7"	6.5 lb (2.9 kg)	791828336531	€ 495
522-060	NMG 50	520-025	50 ft ³ (1.4 m ³)	5.0" X 18.8"	10.0 lb (4.5 kg)	791828336777	€ 644
522-108	NMG 75	520-025	75 ft ³ (2.1 m ³)	5.0" X 18.8"	11.0 lb (5.0 kg)	791828337019	€ 740
522-156	NMG 100	520-049	100 ft ³ (2.8 m ³)	5.2" X 19.0"	13.5 lb (6.1 kg)	791828337255	€ 917

Part numbers listed above are standard configuration; Pressure switch contacts closed under pressure (in service), pressure switch connector - Delphi connector including mating plug with 6" leads, 12V DC light kit. Contact factory for Part # if other configuration is needed.



NFD Line - Automatic Only
FK-5-1-12 Refillable Systems
(Pages 6-7)

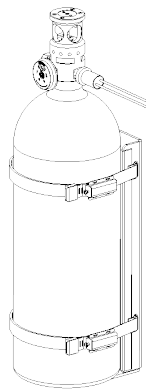

NFD 125-200 A

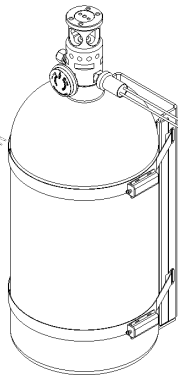

NFD 225-300 A

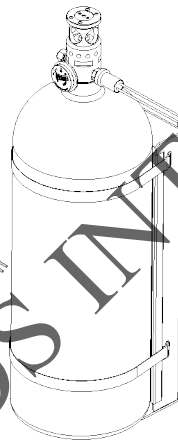

NFD 325-400 A

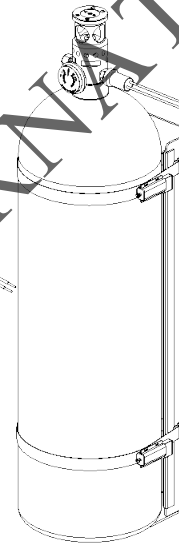

NFD 425-525 A

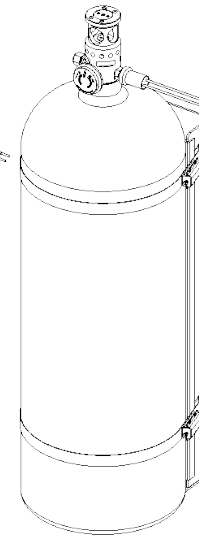

NFD 550-675 A

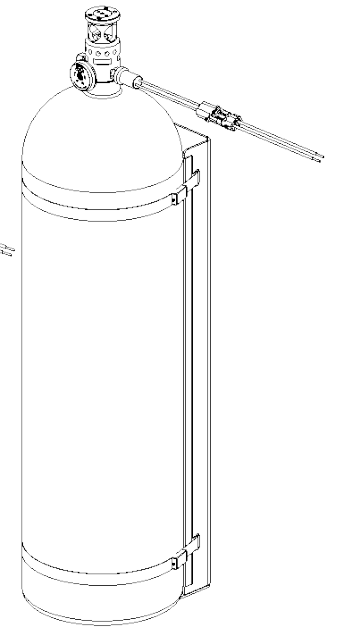

NFD 700-825 A

CLOUDS INTERNATIONAL B>A



NFD Line - Automatic Only FK-5-1-12 Refillable Systems (Pages 6-7)

PN	Model	Datasheet	Volume of Protection	Install Dim.	Ship Weight	UPC Code	List Price- EUR
512-197	NFD 125 A	500-073	125 ft ³ (3.5 m ³)	5.7" X 20.6"	18.0 lb (08.2 kg)	791828149063	€ 964
512-245	NFD 150 A	500-073	150 ft ³ (4.2 m ³)	5.7" X 20.6"	19.5 lb (08.8 kg)	791828149544	€ 1,058
512-293	NFD 175 A	500-073	175 ft ³ (5.0 m ³)	5.7" X 20.6"	21.0 lb (09.5 kg)	791828150021	€ 1,153
512-341	NFD 200 A	500-073	200 ft ³ (5.7 m ³)	5.7" X 20.6"	22.0 lb (10.0 kg)	791828150502	€ 1,250
512-389	NFD 225 A	500-097	225 ft ³ (6.4 m ³)	8.0" X 18.8"	31.0 lb (14.0 kg)	791828150922	€ 1,361
512-437	NFD 250 A	500-097	250 ft ³ (7.1 m ³)	8.0" X 18.8"	33.0 lb (14.9 kg)	791828151400	€ 1,475
512-485	NFD 275 A	500-097	275 ft ³ (7.8 m ³)	8.0" X 18.8"	34.0 lb (15.4 kg)	791828151882	€ 1,588
512-533	NFD 300 A	500-097	300 ft ³ (8.5 m ³)	8.0" X 18.8"	35.5 lb (16.1 kg)	791828152360	€ 1,703
512-581	NFD 325 A	500-121	325 ft ³ (9.2 m ³)	8.0" X 23.4"	41.0 lb (18.5 kg)	791828152841	€ 1,875
512-629	NFD 350 A	500-121	350 ft ³ (9.9 m ³)	8.0" X 23.4"	43.0 lb (19.5 kg)	791828153329	€ 1,989
512-677	NFD 375 A	500-121	375 ft ³ (10.6 m ³)	8.0" X 23.4"	44.0 lb (19.9 kg)	791828153800	€ 2,101
512-725	NFD 400 A	500-121	400 ft ³ (11.3 m ³)	8.0" X 23.4"	45.0 lb (20.4 kg)	791828154289	€ 2,215
512-773	NFD 425 A	500-145	425 ft ³ (12.0 m ³)	8.0" X 27.4"	50.5 lb (22.9 kg)	791828154760	€ 2,441
512-821	NFD 450 A	500-145	450 ft ³ (12.7 m ³)	8.0" X 27.4"	52.0 lb (23.5 kg)	791828155248	€ 2,552
512-869	NFD 475 A	500-145	475 ft ³ (13.4 m ³)	8.0" X 27.4"	53.0 lb (24.0 kg)	791828155729	€ 2,666
512-917	NFD 500 A	500-145	500 ft ³ (14.2 m ³)	8.0" X 27.4"	54.5 lb (24.7 kg)	791828156207	€ 2,779
512-965	NFD 525 A	500-145	525 ft ³ (14.9 m ³)	8.0" X 27.4"	56.0 lb (25.4 kg)	791828156689	€ 2,892
512-1013	NFD 550 A	500-169	550 ft ³ (15.6 m ³)	9.0" X 27.7"	67.0 lb (30.3 kg)	791828157167	€ 3,131
512-1061	NFD 575 A	500-169	575 ft ³ (16.3 m ³)	9.0" X 27.7"	69.0 lb (31.2 kg)	791828157648	€ 3,243
512-1109	NFD 600 A	500-169	600 ft ³ (17.0 m ³)	9.0" X 27.7"	70.0 lb (31.7 kg)	791828158126	€ 3,357
512-1157	NFD 625 A	500-169	625 ft ³ (17.7 m ³)	9.0" X 27.7"	71.0 lb (32.2 kg)	791828158607	€ 3,471
512-1205	NFD 650 A	500-169	650 ft ³ (18.4 m ³)	9.0" X 27.7"	73.0 lb (33.1 kg)	791828159086	€ 3,583
512-1253	NFD 675 A	500-169	675 ft ³ (19.1 m ³)	9.0" X 27.7"	74.0 lb (33.5 kg)	791828159567	€ 3,695
512-1301	NFD 700 A	500-193	700 ft ³ (19.8 m ³)	9.0" X 32.5"	80.5 lb (36.5 kg)	791828160044	€ 3,973
512-1349	NFD 725 A	500-193	725 ft ³ (20.5 m ³)	9.0" X 32.5"	82.0 lb (37.1 kg)	791828160525	€ 4,087
512-1397	NFD 750 A	500-193	750 ft ³ (21.2 m ³)	9.0" X 32.5"	83.0 lb (37.6 kg)	791828161003	€ 4,197
512-1445	NFD 775 A	500-193	775 ft ³ (21.9 m ³)	9.0" X 32.5"	84.5 lb (38.3 kg)	791828161485	€ 4,311
512-1493	NFD 800 A	500-193	800 ft ³ (22.7 m ³)	9.0" X 32.5"	86.0 lb (39.0 kg)	791828161966	€ 4,424
512-1541	NFD 825 A	500-193	825 ft ³ (23.4 m ³)	9.0" X 32.5"	87.0 lb (39.4 kg)	791828162444	€ 4,647

Part numbers listed above are standard configuration; Pressure switch contacts closed under pressure (in service), pressure switch connector - Delphi connector including mating plug with 6" leads, 12V DC light kit. Contact factory for Part # if other configuration is needed.



NFD Line - Manual & Automatic FK-5-1-12 Refillable Systems (Pages 8-11)

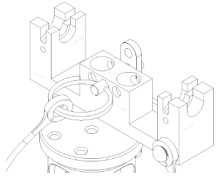

Manual/Automatic Systems require one of the following Bi-Directional discharge assemblies:

- 136-0xxx - Manual/Automatic
- 136-2xxx - Manual/Automatic with Fire Sleeve

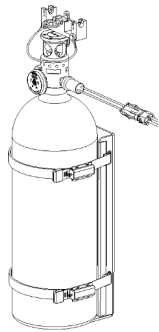

NFD 125-200 M

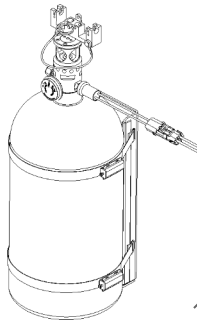

NFD 225-300 M

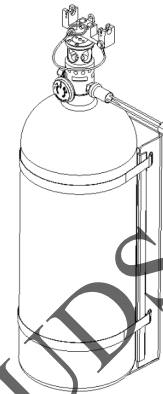

NFD 325-400 M

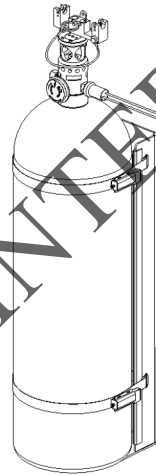

NFD 425-525 M

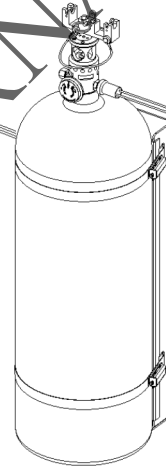

NFD 550-675 M

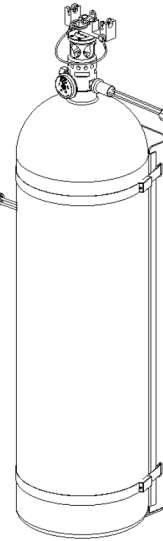

NFD 700-825 M

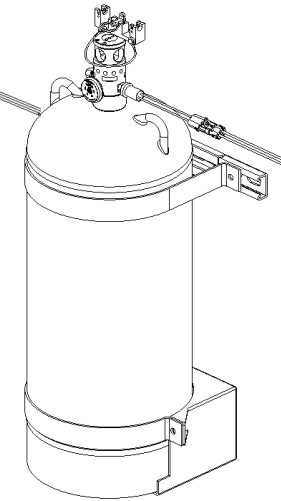

NFD 850-1250 M

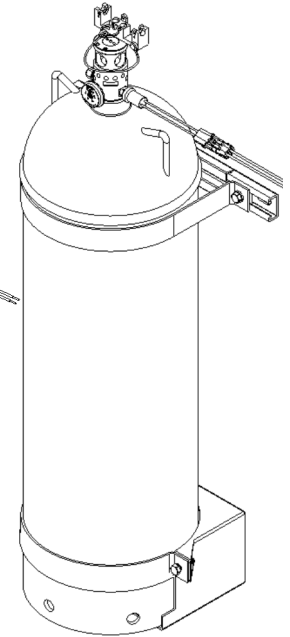

NFD 1275-1800 M

CLOUDS INTERNATIONAL B>A



NFD Line - Manual & Automatic FK-5-1-12 Refillable Systems (Pages 8-11)

PN	Model	Datasheet	Volume of Protection	Install Dim.	Ship Weight	UPC Code	List Price- EUR
512-203	NFD 125 M	500-073	125 ft ³ (3.5 m ³)	5.7" X 20.6"	18.0 lb (8.2 kg)	791828149063	€ 1,054
512-251	NFD 150 M	500-073	150 ft ³ (4.2 m ³)	5.7" X 20.6"	19.5 lb (8.8 kg)	791828149544	€ 1,150
512-299	NFD 175 M	500-073	175 ft ³ (5.0 m ³)	5.7" X 20.6"	21.0 lb (9.5 kg)	791828150021	€ 1,245
512-347	NFD 200 M	500-073	200 ft ³ (5.7 m ³)	5.7" X 20.6"	22.0 lb (10.0 kg)	791828150502	€ 1,341
512-395	NFD 225 M	500-097	225 ft ³ (6.4 m ³)	8.0" X 20.1"	31.0 lb (14.0 kg)	791828150984	€ 1,449
512-443	NFD 250 M	500-097	250 ft ³ (7.1 m ³)	8.0" X 20.1"	33.0 lb (14.9 kg)	791828151462	€ 1,563
512-491	NFD 275 M	500-097	275 ft ³ (7.8 m ³)	8.0" X 20.1"	34.0 lb (15.4 kg)	791828151943	€ 1,677
512-539	NFD 300 M	500-097	300 ft ³ (8.5 m ³)	8.0" X 20.1"	35.5 lb (16.1 kg)	791828152421	€ 1,790
512-587	NFD 325 M	500-121	325 ft ³ (9.2 m ³)	8.0" X 24.7"	41.0 lb (18.5 kg)	791828152902	€ 1,963
512-635	NFD 350 M	500-121	350 ft ³ (9.9 m ³)	8.0" X 24.7"	43.0 lb (19.5 kg)	791828153381	€ 2,075
512-683	NFD 375 M	500-121	375 ft ³ (10.6 m ³)	8.0" X 24.7"	44.0 lb (19.9 kg)	791828153862	€ 2,191
512-731	NFD 400 M	500-121	400 ft ³ (11.3 m ³)	8.0" X 24.7"	45.0 lb (20.4 kg)	791828154340	€ 2,302
512-779	NFD 425 M	500-145	425 ft ³ (12.0 m ³)	8.0" X 28.7"	50.5 lb (22.9 kg)	791828154821	€ 2,527
512-827	NFD 450 M	500-145	450 ft ³ (12.7 m ³)	8.0" X 28.7"	52.0 lb (23.5 kg)	791828155309	€ 2,640
512-875	NFD 475 M	500-145	475 ft ³ (13.4 m ³)	8.0" X 28.7"	53.0 lb (24.0 kg)	791828155781	€ 2,753
512-923	NFD 500 M	500-145	500 ft ³ (14.2 m ³)	8.0" X 28.7"	54.5 lb (24.7 kg)	791828156269	€ 2,868
512-971	NFD 525 M	500-145	525 ft ³ (14.9 m ³)	8.0" X 28.7"	56.0 lb (25.4 kg)	791828156740	€ 2,979
512-1019	NFD 550 M	500-169	550 ft ³ (15.6 m ³)	9.0" X 29.0"	67.0 lb (30.3 kg)	791828157228	€ 3,219
512-1067	NFD 575 M	500-169	575 ft ³ (16.3 m ³)	9.0" X 29.0"	69.0 lb (31.2 kg)	791828157709	€ 3,331
512-1115	NFD 600 M	500-169	600 ft ³ (17.0 m ³)	9.0" X 29.0"	70.0 lb (31.7 kg)	791828158188	€ 3,443
512-1163	NFD 625 M	500-169	625 ft ³ (17.7 m ³)	9.0" X 29.0"	71.0 lb (32.2 kg)	791828158669	€ 3,558
512-1211	NFD 650 M	500-169	650 ft ³ (18.4 m ³)	9.0" X 29.0"	73.0 lb (33.1 kg)	791828159147	€ 3,670
512-1259	NFD 675 M	500-169	675 ft ³ (19.1 m ³)	9.0" X 29.0"	74.0 lb (33.5 kg)	791828159628	€ 3,784
512-1307	NFD 700 M	500-193	700 ft ³ (19.8 m ³)	9.0" X 33.8"	80.5 lb (36.5 kg)	791828160105	€ 4,059
512-1355	NFD 725 M	500-193	725 ft ³ (20.5 m ³)	9.0" X 33.8"	82.0 lb (37.1 kg)	791828160587	€ 4,172
512-1403	NFD 750 M	500-193	750 ft ³ (21.2 m ³)	9.0" X 33.8"	83.0 lb (37.6 kg)	791828161065	€ 4,286
512-1451	NFD 775 M	500-193	775 ft ³ (21.9 m ³)	9.0" X 33.8"	84.5 lb (38.3 kg)	791828161546	€ 4,398
512-1499	NFD 800 M	500-193	800 ft ³ (22.7 m ³)	9.0" X 33.8"	86.0 lb (39.0 kg)	791828162024	€ 4,510
512-1547	NFD 825 M	500-193	825 ft ³ (23.4 m ³)	9.0" X 33.8"	87.0 lb (39.4 kg)	791828162505	€ 4,737

Part numbers listed above are standard configuration; Pressure switch contacts closed under pressure (in service), pressure switch connector - Delphi connector including mating plug with 6" leads, 12V DC light kit. Contact factory for Part # if other configuration is needed.



NFD Line - Manual & Automatic FK-5-1-12 Refillable Systems (Pages 8-11)

PN	Model	Datasheet	Volume of Protection	Install Dim.	Ship Weight	UPC Code	List Price- EUR
512-1589	NFD 850 M	500-217	850 ft ³ (24.1 m ³)	16.5" X 30.7"	112.5 lb (51.0 kg)	791828162925	€ 5,425
512-1613	NFD 875 M	500-217	875 ft ³ (24.8 m ³)	16.5" X 30.7"	114.0 lb (51.7 kg)	791828163168	€ 5,544
512-1637	NFD 900 M	500-217	900 ft ³ (25.5 m ³)	16.5" X 30.7"	115.0 lb (52.1 kg)	791828163403	€ 5,662
512-1661	NFD 925 M	500-217	925 ft ³ (26.2 m ³)	16.5" X 30.7"	116.5 lb (52.8 kg)	791828163649	€ 5,781
512-1685	NFD 950 M	500-217	950 ft ³ (26.9 m ³)	16.5" X 30.7"	118.0 lb (53.5 kg)	791828163885	€ 5,899
512-1709	NFD 975 M	500-217	975 ft ³ (27.6 m ³)	16.5" X 30.7"	119.0 lb (53.9 kg)	791828164127	€ 6,017
512-1733	NFD 1000 M	500-217	1000 ft ³ (28.3 m ³)	16.5" X 30.7"	120.5 lb (54.6 kg)	791828164363	€ 6,134
512-1757	NFD 1025 M	500-217	1025 ft ³ (29.0 m ³)	16.5" X 30.7"	122.0 lb (55.3 kg)	791828164608	€ 6,255
512-1781	NFD 1050 M	500-217	1050 ft ³ (29.7 m ³)	16.5" X 30.7"	123.0 lb (55.7 kg)	791828164844	€ 6,372
512-1805	NFD 1075 M	500-217	1075 ft ³ (30.4 m ³)	16.5" X 30.7"	124.5 lb (56.4 kg)	791828165087	€ 6,490
512-1829	NFD 1100 M	500-217	1100 ft ³ (31.1 m ³)	16.5" X 30.7"	126.0 lb (57.1 kg)	791828165322	€ 6,609
512-1853	NFD 1125 M	500-217	1125 ft ³ (31.9 m ³)	16.5" X 30.7"	127.0 lb (57.6 kg)	791828165568	€ 6,725
512-1877	NFD 1150 M	500-217	1150 ft ³ (32.6 m ³)	16.5" X 30.7"	128.5 lb (58.2 kg)	791828165803	€ 6,847
512-1901	NFD 1175 M	500-217	1175 ft ³ (33.3 m ³)	16.5" X 30.7"	130.0 lb (58.9 kg)	791828166046	€ 6,964
512-1925	NFD 1200 M	500-217	1200 ft ³ (34.0 m ³)	16.5" X 30.7"	131.0 lb (59.4 kg)	791828166282	€ 7,082
512-1949	NFD 1225 M	500-217	1225 ft ³ (34.7 m ³)	16.5" X 30.7"	132.5 lb (60.1 kg)	791828166527	€ 7,200
512-1973	NFD 1250 M	500-217	1250 ft ³ (35.4 m ³)	16.5" X 30.7"	134.0 lb (60.7 kg)	791828166763	€ 7,319

CLOUDS INTERNATIONAL B

Part numbers listed above are standard configuration; Pressure switch contacts closed under pressure (in service), pressure switch connector - Delphi connector including mating plug with 6" leads, 12V DC light kit. Contact factory for Part # if other configuration is needed.



NFD Line - Manual & Automatic FK-5-1-12 Refillable Systems (Pages 8-11)

PN	Model	Datasheet	Volume of Protection	Install Dim.	Ship Weight	UPC Code	List Price- EUR
512-1997	NFD 1275 M	500-229	1275 ft ³ (36.1 m ³)	16.5" X 39.9"	148.0 lb (67.1 kg)	791828167005	€ 7,315
512-2021	NFD 1300 M	500-229	1300 ft ³ (36.8 m ³)	16.5" X 39.9"	149.0 lb (67.5 kg)	791828167241	€ 7,427
512-2045	NFD 1325 M	500-229	1325 ft ³ (37.5 m ³)	16.5" X 39.9"	151.0 lb (68.4 kg)	791828167487	€ 7,543
512-2069	NFD 1350 M	500-229	1350 ft ³ (38.2 m ³)	16.5" X 39.9"	152.0 lb (68.9 kg)	791828167722	€ 7,655
512-2093	NFD 1375 M	500-229	1375 ft ³ (38.9 m ³)	16.5" X 39.9"	153.0 lb (69.3 kg)	791828167968	€ 7,768
512-2117	NFD 1400 M	500-229	1400 ft ³ (39.6 m ³)	16.5" X 39.9"	154.5 lb (70.0 kg)	791828168200	€ 7,880
512-2141	NFD 1425 M	500-229	1425 ft ³ (40.3 m ³)	16.5" X 39.9"	156.0 lb (70.7 kg)	791828168446	€ 7,994
512-2165	NFD 1450 M	500-229	1450 ft ³ (41.1 m ³)	16.5" X 39.9"	157.0 lb (71.2 kg)	791828168682	€ 8,106
512-2189	NFD 1475 M	500-229	1475 ft ³ (41.8 m ³)	16.5" X 39.9"	158.5 lb (71.8 kg)	791828168927	€ 8,218
512-2213	NFD 1500 M	500-229	1500 ft ³ (42.5 m ³)	16.5" X 39.9"	160.0 lb (72.5 kg)	791828169160	€ 8,332
512-2237	NFD 1525 M	500-229	1525 ft ³ (43.2 m ³)	16.5" X 39.9"	161.0 lb (73.0 kg)	791828169405	€ 8,444
512-2261	NFD 1550 M	500-229	1550 ft ³ (43.9 m ³)	16.5" X 39.9"	162.5 lb (73.7 kg)	791828169641	€ 8,559
512-2285	NFD 1575 M	500-229	1575 ft ³ (44.6 m ³)	16.5" X 39.9"	164.0 lb (74.3 kg)	791828169887	€ 8,671
512-2309	NFD 1600 M	500-229	1600 ft ³ (45.3 m ³)	16.5" X 39.9"	165.0 lb (74.8 kg)	791828170128	€ 8,784
512-2333	NFD 1625 M	500-229	1625 ft ³ (46.0 m ³)	16.5" X 39.9"	166.5 lb (75.5 kg)	791828170364	€ 8,897
512-2357	NFD 1650 M	500-229	1650 ft ³ (46.7 m ³)	16.5" X 39.9"	168.0 lb (76.2 kg)	791828170609	€ 9,009
512-2381	NFD 1675 M	500-229	1675 ft ³ (47.4 m ³)	16.5" X 39.9"	169.0 lb (76.6 kg)	791828170845	€ 9,122
512-2405	NFD 1700 M	500-229	1700 ft ³ (48.1 m ³)	16.5" X 39.9"	170.5 lb (77.3 kg)	791828171088	€ 9,235
512-2429	NFD 1725 M	500-229	1725 ft ³ (48.8 m ³)	16.5" X 39.9"	172.0 lb (78.0 kg)	791828171323	€ 9,348
512-2453	NFD 1750 M	500-229	1750 ft ³ (49.6 m ³)	16.5" X 39.9"	173.0 lb (78.4 kg)	791828171569	€ 9,459
512-2477	NFD 1775 M	500-229	1775 ft ³ (50.3 m ³)	16.5" X 39.9"	174.5 lb (79.1 kg)	791828171804	€ 9,576
512-2501	NFD 1800 M	500-229	1800 ft ³ (51.0 m ³)	16.5" X 39.9"	176.0 lb (79.8 kg)	791828172047	€ 9,687

Part numbers listed above are standard configuration; Pressure switch contacts closed under pressure (in service), pressure switch connector - Delphi connector including mating plug with 6" leads, 12V DC light kit. Contact factory for Part # if other configuration is needed.



NMD Line - Manual Only FK-5-1-12 Refillable Systems

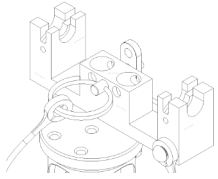

Manual Only Systems require one of the following Bi-Directional discharge assemblies:

- 136-5xxx - Manual Only*
- 136-6xxx - Manual Only with Fire Sleeve

*When 136-5xxx cables are used, an appropriate length of 138-2xxx Fire Sleeve must be installed over the cable within the protected space.

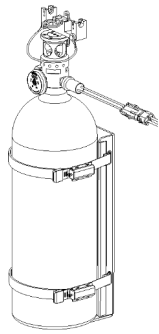

NMD 125-200

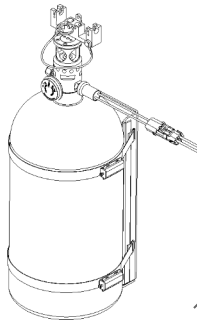

NMD 225-300

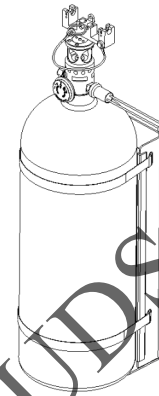

NMD 325-400

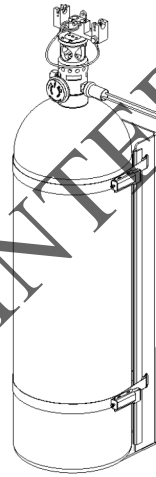

NMD 425-525

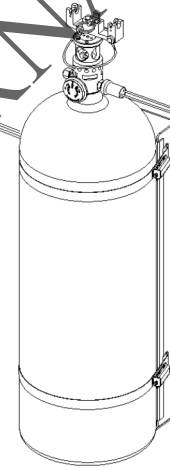

NMD 550-675

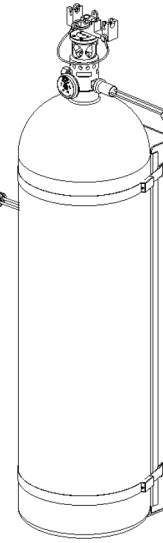

NMD 700-825

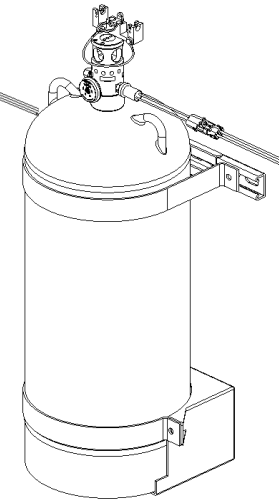

NMD 850-1250

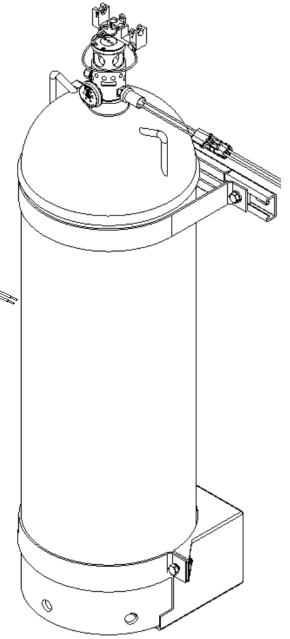

NMD 1275-1800

CLOUDS INTERNATIONAL B.V.



NMD Line - Manual Only FK-5-1-12 Refillable Systems

PN	Model	Datasheet	Volume of Protection	Install Dim.	Ship Weight	UPC Code	List Price- EUR
522-204	NMD 125	520-073	125 ft ³ (3.5 m ³)	5.7" X 20.6"	18.0 lb (8.2 kg)	791828337491	€ 1,054
522-252	NMD 150	520-073	150 ft ³ (4.2 m ³)	5.7" X 20.6"	19.5 lb (8.8 kg)	791828337736	€ 1,150
522-300	NMD 175	520-073	175 ft ³ (5.0 m ³)	5.7" X 20.6"	21.0 lb (9.5 kg)	791828337972	€ 1,245
522-348	NMD 200	520-073	200 ft ³ (5.7 m ³)	5.7" X 20.6"	22.0 lb (10.0 kg)	791828338214	€ 1,341
532-396	NMD 225	520-097	225 ft ³ (6.4 m ³)	8.0" X 20.1"	31.0 lb(14.0 kg)	791828338450	€ 1,449
532-444	NMD 250	520-097	250 ft ³ (7.1 m ³)	8.0" X 20.1"	33.0 lb(14.9 kg)	791828338696	€ 1,563
532-492	NMD 275	520-097	275 ft ³ (7.8 m ³)	8.0" X 20.1"	34.0 lb(15.4 kg)	791828338931	€ 1,677
532-540	NMD 300	520-097	300 ft ³ (8.5 m ³)	8.0" X 20.1"	35.5 lb(16.1 kg)	791828339174	€ 1,790
532-588	NMD 325	520-121	325 ft ³ (9.2 m ³)	8.0" X 24.7"	41.0 lb(18.5 kg)	791828339419	€ 1,963
532-636	NMD 350	520-121	350 ft ³ (9.9 m ³)	8.0" X 24.7"	43.0 lb(19.5 kg)	791828339655	€ 2,075
532-684	NMD 375	520-121	375 ft ³ (10.6 m ³)	8.0" X 24.7"	44.0 lb(19.9 kg)	791828339891	€ 2,191
532-732	NMD 400	520-121	400 ft ³ (11.3 m ³)	8.0" X 24.7"	45.0 lb(20.4 kg)	791828340132	€ 2,302
532-780	NMD 425	520-145	425 ft ³ (12.0 m ³)	8.0" X 28.7"	50.5 lb(22.9 kg)	791828340378	€ 2,527
532-828	NMD 450	520-145	450 ft ³ (12.7 m ³)	8.0" X 28.7"	52.0 lb(23.5 kg)	791828340613	€ 2,640
532-876	NMD 475	520-145	475 ft ³ (13.4 m ³)	8.0" X 28.7"	53.0 lb(24.0 kg)	791828340859	€ 2,753
532-924	NMD 500	520-145	500 ft ³ (14.2 m ³)	8.0" X 28.7"	54.5 lb(24.7 kg)	791828341092	€ 2,868
532-972	NMD 525	520-145	525 ft ³ (14.9 m ³)	8.0" X 28.7"	56.0 lb(25.4 kg)	791828341337	€ 2,979
532-1020	NMD 550	520-169	550 ft ³ (15.6 m ³)	9.0" X 29.0"	67.0 lb (30.3 kg)	791828341573	€ 3,219
532-1068	NMD 575	520-169	575 ft ³ (16.3 m ³)	9.0" X 29.0"	69.0 lb (31.2 kg)	791828341818	€ 3,331
532-1116	NMD 600	520-169	600 ft ³ (17.0 m ³)	9.0" X 29.0"	70.0 lb (31.7 kg)	791828342051	€ 3,443
532-1164	NMD 625	520-169	625 ft ³ (17.7 m ³)	9.0" X 29.0"	71.0 lb (32.2 kg)	791828342297	€ 3,558
532-1212	NMD 650	520-169	650 ft ³ (18.4 m ³)	9.0" X 29.0"	73.0 lb (33.1 kg)	791828342532	€ 3,670
532-1260	NMD 675	520-169	675 ft ³ (19.1 m ³)	9.0" X 29.0"	74.0 lb (33.5 kg)	791828342778	€ 3,784
532-1308	NMD 700	520-193	700 ft ³ (19.8 m ³)	9.0" X 33.8"	80.5 lb (36.5 kg)	791828343010	€ 4,059
532-1356	NMD 725	520-193	725 ft ³ (20.5 m ³)	9.0" X 33.8"	82.0 lb (37.1 kg)	791828343256	€ 4,172
532-1404	NMD 750	520-193	750 ft ³ (21.2 m ³)	9.0" X 33.8"	83.0 lb (37.6 kg)	791828343492	€ 4,286
532-1452	NMD 775	520-193	775 ft ³ (21.9 m ³)	9.0" X 33.8"	84.5 lb (38.3 kg)	791828343737	€ 4,398
532-1500	NMD 800	520-193	800 ft ³ (22.7 m ³)	9.0" X 33.8"	86.0 lb (39.0 kg)	791828343973	€ 4,510
532-1548	NMD 825	520-193	825 ft ³ (23.4 m ³)	9.0" X 33.8"	87.0 lb (39.4 kg)	791828344215	€ 4,737

Part numbers listed above are standard configuration; Pressure switch contacts closed under pressure (in service), pressure switch connector - Delphi connector including mating plug with 6" leads, 12V DC light kit. Contact factory for Part # if other configuration is needed.



NMD Line - Manual Only FK-5-1-12 Refillable Systems

PN	Model	Datasheet	Volume of Protection	Install Dim.	Ship Weight	UPC Code	List Price- EUR
532-1589	NMD 850	520-217	850 ft ³ (24.1 m ³)	16.5" X 30.7"	112.5 lb(51.0 kg)	791828344420	€ 5,425
532-1613	NMD 875	520-217	875 ft ³ (24.8 m ³)	16.5" X 30.7"	114.0 lb(51.7 kg)	791828344543	€ 5,544
532-1637	NMD 900	520-217	900 ft ³ (25.5 m ³)	16.5" X 30.7"	115.0 lb(52.1 kg)	791828344666	€ 5,662
532-1661	NMD 925	520-217	925 ft ³ (26.2 m ³)	16.5" X 30.7"	116.5 lb(52.8 kg)	791828344789	€ 5,781
532-1685	NMD 950	520-217	950 ft ³ (26.9 m ³)	16.5" X 30.7"	118.0 lb(53.5 kg)	791828344901	€ 5,899
532-1709	NMD 975	520-217	975 ft ³ (27.6 m ³)	16.5" X 30.7"	119.0 lb(53.9 kg)	791828345021	€ 6,017
532-1733	NMD 1000	520-217	1000 ft ³ (28.3 m ³)	16.5" X 30.7"	120.5 lb(54.6kg)	791828345144	€ 6,134
532-1757	NMD 1025	520-217	1025 ft ³ (29.0 m ³)	16.5" X 30.7"	122.0 lb(55.3 kg)	791828345267	€ 6,255
532-1781	NMD 1050	520-217	1050 ft ³ (29.7 m ³)	16.5" X 30.7"	123.0 lb(55.7 kg)	791828345380	€ 6,372
532-1805	NMD 1075	520-217	1075 ft ³ (30.4 m ³)	16.5" X 30.7"	124.5 lb(56.4 kg)	791828345502	€ 6,490
532-1829	NMD 1100	520-217	1100 ft ³ (31.1 m ³)	16.5" X 30.7"	126.0 lb(57.1 kg)	791828345625	€ 6,609
532-1853	NMD 1125	520-217	1125 ft ³ (31.9 m ³)	16.5" X 30.7"	127.0 lb(57.6 kg)	791828345748	€ 6,725
532-1877	NMD 1150	520-217	1150 ft ³ (32.6 m ³)	16.5" X 30.7"	128.5 lb(58.2 kg)	791828345861	€ 6,847
532-1901	NMD 1175	520-217	1175 ft ³ (33.3 m ³)	16.5" X 30.7"	130.0 lb (58.9 kg)	791828345984	€ 6,964
532-1925	NMD 1200	520-217	1200 ft ³ (34.0 m ³)	16.5" X 30.7"	131.0 lb (59.4 kg)	791828346103	€ 7,082
532-1949	NMD 1225	520-217	1225 ft ³ (34.7 m ³)	16.5" X 30.7"	132.5 lb (60.1 kg)	791828346226	€ 7,200
532-1973	NMD 1250	520-217	1250 ft ³ (35.4 m ³)	16.5" X 30.7"	134.0 lb (60.7kg)	791828346349	€ 7,319

CLOUDS INTERNATIONAL B.V.

Part numbers listed above are standard configuration; Pressure switch contacts closed under pressure (in service), pressure switch connector - Delphi connector including mating plug with 6" leads, 12V DC light kit. Contact factory for Part # if other configuration is needed.



NMD Line - Manual Only FK-5-1-12 Refillable Systems

PN	Model	Datasheet	Volume of Protection	Install Dim.	Ship Weight	UPC Code	List Price- EUR
532-1997	NMD 1275	520-229	1275 ft ³ (36.1 m ³)	16.5" X 39.9"	148.0 lb (67.1 kg)	791828346462	€ 7,315
532-2021	NMD 1300	520-229	1300 ft ³ (36.8 m ³)	16.5" X 39.9"	149.0 lb (67.5 kg)	791828346585	€ 7,427
532-2045	NMD 1325	520-229	1325 ft ³ (37.5 m ³)	16.5" X 39.9"	151.0 lb (68.4 kg)	791828346707	€ 7,543
532-2069	NMD 1350	520-229	1350 ft ³ (38.2 m ³)	16.5" X 39.9"	152.0 lb (68.9 kg)	791828346820	€ 7,655
532-2093	NMD 1375	520-229	1375 ft ³ (38.9 m ³)	16.5" X 39.9"	153.0 lb (69.3 kg)	791828346943	€ 7,768
532-2117	NMD 1400	520-229	1400 ft ³ (39.6 m ³)	16.5" X 39.9"	154.5 lb (70.0 kg)	791828347063	€ 7,880
532-2141	NMD 1425	520-229	1425 ft ³ (40.3 m ³)	16.5" X 39.9"	156.0 lb (70.7 kg)	791828347186	€ 7,994
532-2165	NMD 1450	520-229	1450 ft ³ (41.1 m ³)	16.5" X 39.9"	157.0 lb (71.2 kg)	791828347308	€ 8,106
532-2189	NMD 1475	520-229	1475 ft ³ (41.8 m ³)	16.5" X 39.9"	158.5 lb (71.8 kg)	791828347421	€ 8,218
532-2213	NMD 1500	520-229	1500 ft ³ (42.5 m ³)	16.5" X 39.9"	160.0 lb (72.5 kg)	791828347544	€ 8,332
532-2237	NMD 1525	520-229	1525 ft ³ (43.2 m ³)	16.5" X 39.9"	161.0 lb (73.0 kg)	791828347667	€ 8,444
532-2261	NMD 1550	520-229	1550 ft ³ (43.9 m ³)	16.5" X 39.9"	162.5 lb (73.7 kg)	791828347780	€ 8,559
532-2285	NMD 1575	520-229	1575 ft ³ (44.6 m ³)	16.5" X 39.9"	164.0 lb (74.3 kg)	791828347902	€ 8,671
532-2309	NMD 1600	520-229	1600 ft ³ (45.3 m ³)	16.5" X 39.9"	165.0 lb (74.8 kg)	791828348022	€ 8,784
532-2333	NMD 1625	520-229	1625 ft ³ (46.0 m ³)	16.5" X 39.9"	166.5 lb (75.5 kg)	791828348145	€ 8,897
532-2357	NMD 1650	520-229	1650 ft ³ (46.7 m ³)	16.5" X 39.9"	168.0 lb (76.2 kg)	791828348268	€ 9,009
532-2381	NMD 1675	520-229	1675 ft ³ (47.4 m ³)	16.5" X 39.9"	169.0 lb (76.6 kg)	791828348381	€ 9,122
532-2405	NMD 1700	520-229	1700 ft ³ (48.1 m ³)	16.5" X 39.9"	170.5 lb (77.3 kg)	791828348503	€ 9,235
532-2429	NMD 1725	520-229	1725 ft ³ (48.8 m ³)	16.5" X 39.9"	172.0 lb (78.0 kg)	791828348626	€ 9,348
532-2453	NMD 1750	520-229	1750 ft ³ (49.6 m ³)	16.5" X 39.9"	173.0 lb (78.4 kg)	791828348749	€ 9,459
532-2477	NMD 1775	520-229	1775 ft ³ (50.3 m ³)	16.5" X 39.9"	174.5 lb (79.1 kg)	791828348862	€ 9,576
532-2501	NMD 1800	520-229	1800 ft ³ (51.0 m ³)	16.5" X 39.9"	176.0 lb (79.8 kg)	791828348985	€ 9,687

Part numbers listed above are standard configuration; Pressure switch contacts closed under pressure (in service), pressure switch connector - Delphi connector including mating plug with 6" leads, 12V DC light kit. Contact factory for Part # if other configuration is needed.



Manual Release Cable Kits

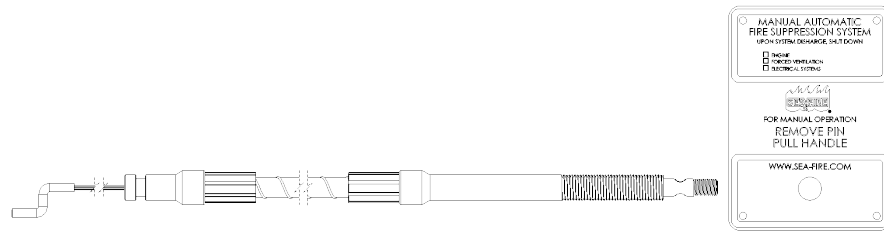

Bi-Directional Cable - Manual/Automatic Faceplate

Part #	Length	Ship Weight	UPC Code	List Price- EUR
136-0006	6 ft (1.83 m)	3 lb (1.4 kg)	791828138289	€ 124
136-0008	8 ft (2.44 m)	4 lb (1.8 kg)	791828138302	€ 134
136-0010	10 ft (3.05 m)	4 lb (1.8 kg)	791828138326	€ 140
136-0012	12 ft (3.66 m)	4 lb (1.8 kg)	791828138340	€ 155
136-0014	14 ft (4.27 m)	4 lb (1.8 kg)	791828138364	€ 166
136-0016	16 ft (4.88 m)	5 lb (2.3 kg)	791828138388	€ 181
136-0018	18 ft (5.49 m)	5 lb (2.3 kg)	791828138401	€ 177
136-0020	20 ft (6.1 m)	5 lb (2.3 kg)	791828138425	€ 189
136-0022	22 ft (6.71 m)	5 lb (2.3 kg)	791828138449	€ 202
136-0024	24 ft (7.32 m)	6 lb (2.7 kg)	791828138463	€ 213
136-0026	26 ft (7.93 m)	6 lb (2.7 kg)	791828138487	€ 225
136-0028	28 ft (8.54 m)	6 lb (2.7 kg)	791828138500	€ 237
136-0030	30 ft (9.15 m)	6 lb (2.7 kg)	791828138524	€ 251
136-0032	32 ft (9.15 m)	6 lb (2.7 kg)	791828138548	€ 260
136-0034	34 ft (10.36 m)	7 lb (3.2 kg)	791828138562	€ 274
136-0036	36 ft (10.97 m)	7 lb (3.2 kg)	791828138586	€ 284
136-0038	38 ft (11.58 m)	7 lb (3.2 kg)	791828138609	€ 298
136-0040	40 ft (12.19 m)	7 lb (3.2 kg)	791828138623	€ 307

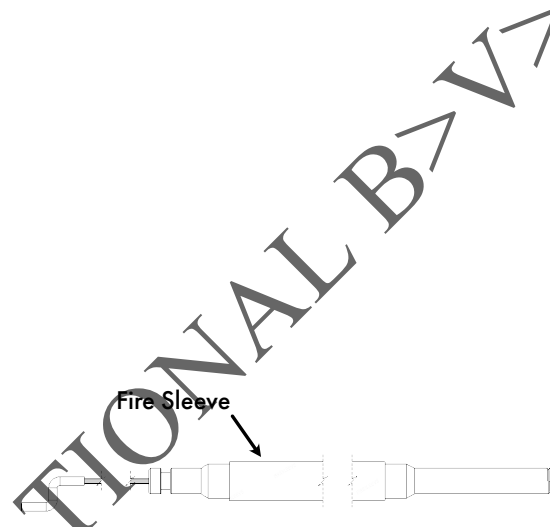

Bi-Directional Cable - Manual/Automatic Faceplate with Fire Sleeve

Part #	Length	Ship Weight	UPC Code	List Price- EUR
136-2006	6 ft (1.83 m)	4 lb (1.8 kg)	791828139040	€ 230
136-2008	8 ft (2.44 m)	5 lb (2.3 kg)	791828139064	€ 276
136-2010	10 ft (3.05 m)	5 lb (2.3 kg)	791828139088	€ 313
136-2012	12 ft (3.66 m)	5 lb (2.3 kg)	791828139101	€ 355
136-2014	14 ft (4.27 m)	6 lb (2.7 kg)	791828139125	€ 396
136-2016	16 ft (4.88 m)	7 lb (3.2 kg)	791828139149	€ 444
136-2018	18 ft (5.49 m)	7 lb (3.2 kg)	791828139163	€ 463
136-2020	20 ft (6.1 m)	7 lb (3.2 kg)	791828139187	€ 507
136-2022	22 ft (6.71 m)	7 lb (3.2 kg)	791828139200	€ 552
136-2024	24 ft (7.32 m)	8 lb (3.6 kg)	791828139224	€ 595
136-2026	26 ft (7.93 m)	8 lb (3.6 kg)	791828139248	€ 639
136-2028	28 ft (8.54 m)	9 lb (4.1 kg)	791828139262	€ 683
136-2030	30 ft (9.15 m)	9 lb (4.1 kg)	791828139286	€ 727
136-2032	32 ft (9.15 m)	10 lb (4.5 kg)	791828139309	€ 772
136-2034	34 ft (10.36 m)	10 lb (4.5 kg)	791828139323	€ 815
136-2036	36 ft (10.97 m)	10 lb (4.5 kg)	791828139347	€ 848
136-2038	38 ft (11.58 m)	10 lb (4.5 kg)	791828139361	€ 892
136-2040	40 ft (12.19 m)	10 lb (4.5 kg)	791828139385	€ 937



Manual Release Cable Kits

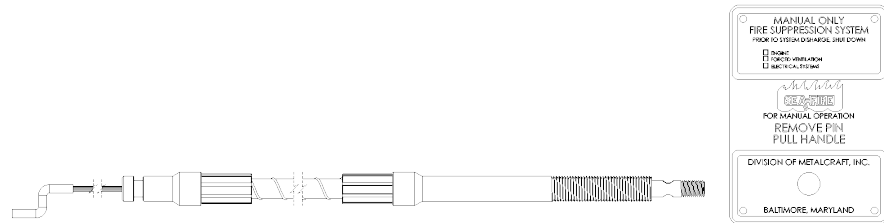

Bi-Directional Cable - Manual Only Faceplate

Part #	Length	Ship Weight	UPC Code	List Price- EUR
136-5006	6 ft (1.83 m)	3 lb (1.4 kg)	791828141326	€ 124
136-5008	8 ft (2.44 m)	4 lb (1.8 kg)	791828141340	€ 134
136-5010	10 ft (3.05 m)	4 lb (1.8 kg)	791828141364	€ 140
136-5012	12 ft (3.66 m)	4 lb (1.8 kg)	791828141388	€ 155
136-5014	14 ft (4.27 m)	4 lb (1.8 kg)	791828141401	€ 166
136-5016	16 ft (4.88 m)	5 lb (2.3 kg)	791828141425	€ 181
136-5018	18 ft (5.49 m)	5 lb (2.3 kg)	791828141449	€ 177
136-5020	20 ft (6.1 m)	5 lb (2.3 kg)	791828141463	€ 189
136-5022	22 ft (6.71 m)	5 lb (2.3 kg)	791828141487	€ 202
136-5024	24 ft (7.32 m)	6 lb (2.7 kg)	791828141500	€ 213
136-5026	26 ft (7.93 m)	6 lb (2.7 kg)	791828141524	€ 225
136-5028	28 ft (8.54 m)	6 lb (2.7 kg)	791828141548	€ 237
136-5030	30 ft (9.15 m)	6 lb (2.7 kg)	791828141562	€ 251
136-5032	32 ft (9.15 m)	6 lb (2.7 kg)	791828141586	€ 260
136-5034	34 ft (10.36 m)	7 lb (3.2 kg)	791828141609	€ 274
136-5036	36 ft (10.97 m)	7 lb (3.2 kg)	791828141623	€ 284
136-5038	38 ft (11.58 m)	7 lb (3.2 kg)	791828141647	€ 298
136-5040	40 ft (12.19 m)	7 lb (3.2 kg)	791828141661	€ 307

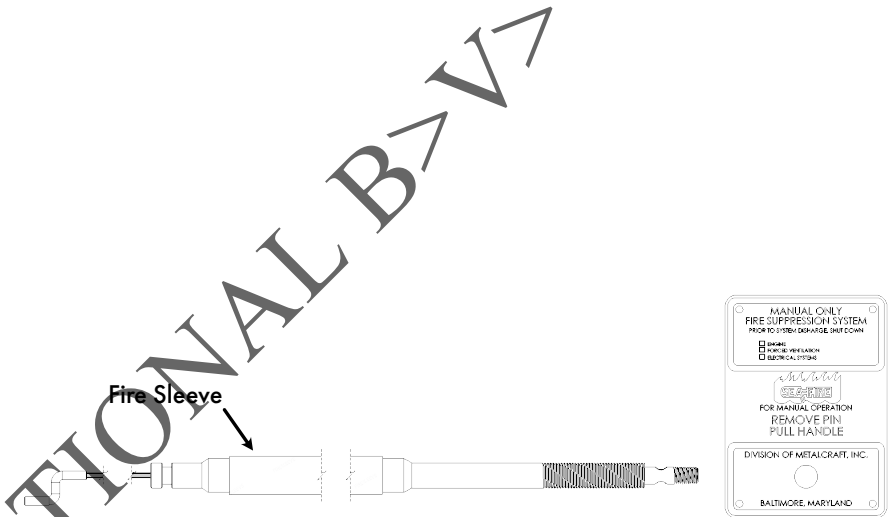

Bi-Directional Cable - Manual Only Faceplate with Fire Sleeve

Part #	Length	Ship Weight	UPC Code	List Price- EUR
136-6006	6 ft (1.83 m)	4 lb (1.8 kg)	791828142088	€ 230
136-6008	8 ft (2.44 m)	5 lb (2.3 kg)	791828142101	€ 276
136-6010	10 ft (3.05 m)	5 lb (2.3 kg)	791828142125	€ 313
136-6012	12 ft (3.66 m)	5 lb (2.3 kg)	791828142149	€ 355
136-6014	14 ft (4.27 m)	6 lb (2.7 kg)	791828142163	€ 396
136-6016	16 ft (4.88 m)	7 lb (3.2 kg)	791828142187	€ 444
136-6018	18 ft (5.49 m)	7 lb (3.2 kg)	791828142200	€ 463
136-6020	20 ft (6.1 m)	7 lb (3.2 kg)	791828142224	€ 507
136-6022	22 ft (6.71 m)	7 lb (3.2 kg)	791828142248	€ 552
136-6024	24 ft (7.32 m)	8 lb (3.6 kg)	791828142262	€ 595
136-6026	26 ft (7.93 m)	8 lb (3.6 kg)	791828142286	€ 639
136-6028	28 ft (8.54 m)	9 lb (4.1 kg)	791828142309	€ 683
136-6030	30 ft (9.15 m)	9 lb (4.1 kg)	791828142323	€ 727
136-6032	32 ft (9.15 m)	10 lb (4.5 kg)	791828142347	€ 772
136-6034	34 ft (10.36 m)	10 lb (4.5 kg)	791828142361	€ 815
136-6036	36 ft (10.97 m)	10 lb (4.5 kg)	791828142385	€ 848
136-6038	38 ft (11.58 m)	10 lb (4.5 kg)	791828142408	€ 892
136-6040	40 ft (12.19 m)	10 lb (4.5 kg)	791828142422	€ 937



AT Series Compact Aerosol Fire Suppression System

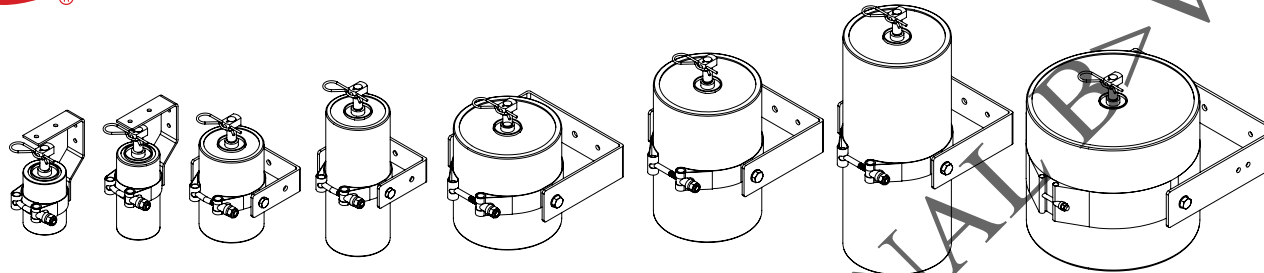

Manual + Automatic*

PN	Model	Volume of Protection	Diameter	Total Length	Weight	List Price- EUR
753-121	AT-194	19.4 ft ³	2.0 in (51 mm)	4.3 in (109 mm)	0.70 lb (0.33 kg)	€ 360
753-221	AT-385	38.5 ft ³	2.0 in (51 mm)	5.6 in (143 mm)	0.90 lb (0.42 kg)	€ 450
753-321	AT-593	59.3 ft ³	3.0 in (76 mm)	6.0 in (152 mm)	1.90 lb (0.86 kg)	€ 630
753-421	AT-1490	149 ft ³	5.0 in (127 mm)	6.5 in (166 mm)	5.60 lb (2.51 kg)	€ 900
753-621	AT-3210	321 ft ³	5.0 in (127 mm)	8.5 in (216 mm)	7.50 lb (3.40 kg)	€ 1,260
753-721	AT-6420	642 ft ³	8.0 in (203 mm)	8.0 in (203.2 mm)	17.97 lb (8.15 kg)	€ 1,800

Automatic Only*

PN	Model	Volume of Protection	Diameter	Total Length	Weight	List Price- EUR
751-113	AT-194	19.4 ft ³	2.0 in (51 mm)	4.3 in (109 mm)	0.70 lb (0.33 kg)	€ 360
751-213	AT-385	38.5 ft ³	2.0 in (51 mm)	5.6 in (143 mm)	0.90 lb (0.42 kg)	€ 450
751-313	AT-593	59.3 ft ³	3.0 in (76 mm)	6.0 in (152 mm)	1.90 lb (0.86 kg)	€ 630
751-413	AT-1490	149 ft ³	5.0 in (127 mm)	6.5 in (166 mm)	5.60 lb (2.51 kg)	€ 900
751-613	AT-3210	321 ft ³	5.0 in (127 mm)	8.5 in (216 mm)	7.50 lb (3.40 kg)	€ 1,260
751-713	AT-6420	642 ft ³	8.0 in (203 mm)	8.0 in (203.2 mm)	17.97 lb (8.15 kg)	€ 1,800

Manual Only

PN	Model	Volume of Protection	Diameter	Total Length	Weight	List Price- EUR
752-105	AT-194	19.4 ft ³	2.0 in (51 mm)	4.3 in (109 mm)	0.70 lb (0.33 kg)	€ 360
752-205	AT-385	38.5 ft ³	2.0 in (51 mm)	5.6 in (143 mm)	0.90 lb (0.42 kg)	€ 450
752-305	AT-593	59.3 ft ³	3.0 in (76 mm)	6.0 in (152 mm)	1.90 lb (0.86 kg)	€ 630
752-405	AT-1490	149 ft ³	5.0 in (127 mm)	6.5 in (166 mm)	5.60 lb (2.51 kg)	€ 900
752-605	AT-3210	321 ft ³	5.0 in (127 mm)	8.5 in (216 mm)	7.50 lb (3.40 kg)	€ 1,260
752-705	AT-6420	642 ft ³	8.0 in (203 mm)	8.0 in (203.2 mm)	17.97 lb (8.15 kg)	€ 1,800

*Systems Ship Complete with generator, mounting bracket, 203°F (95°C) activation head, and remote display



AT Series - Cables

AT Series Cable

Part #	Length	Ship Weight	UPC Code	List Price- EUR
139-0006	6 ft (1.83 m)	3 lb (1.4 kg)	791828141326	€ 146
139-0008	8 ft (2.44 m)	4 lb (1.8 kg)	791828141340	€ 155
139-0010	10 ft (3.05 m)	4 lb (1.8 kg)	791828141364	€ 161
139-0012	12 ft (3.66 m)	4 lb (1.8 kg)	791828141388	€ 173
139-0014	14 ft (4.27 m)	4 lb (1.8 kg)	791828141401	€ 183
139-0016	16 ft (4.88 m)	5 lb (2.3 kg)	791828141425	€ 196
139-0018	18 ft (5.49 m)	5 lb (2.3 kg)	791828141449	€ 200
139-0020	20 ft (6.1 m)	5 lb (2.3 kg)	791828141463	€ 210
139-0022	22 ft (6.71 m)	5 lb (2.3 kg)	791828141487	€ 223
139-0024	24 ft (7.32 m)	6 lb (2.7 kg)	791828141500	€ 232
139-0026	26 ft (7.93 m)	6 lb (2.7 kg)	791828141524	€ 244
139-0028	28 ft (8.54 m)	6 lb (2.7 kg)	791828141548	€ 254
139-0030	30 ft (9.15 m)	6 lb (2.7 kg)	791828141562	€ 267
139-0032	32 ft (9.15 m)	6 lb (2.7 kg)	791828141586	€ 275
139-0034	34 ft (10.36 m)	7 lb (3.2 kg)	791828141609	€ 288
139-0036	36 ft (10.97 m)	7 lb (3.2 kg)	791828141623	€ 297
139-0038	38 ft (11.58 m)	7 lb (3.2 kg)	791828141647	€ 310
139-0040	40 ft (12.19 m)	7 lb (3.2 kg)	791828141661	€ 318

AT Series Cable with Fire Sleeve

Part #	Length	Ship Weight	UPC Code	List Price- EUR
139-5006	6 ft (1.83 m)	4 lb (1.8 kg)	791828142088	€ 239
139-5008	8 ft (2.44 m)	5 lb (2.3 kg)	791828142101	€ 279
139-5010	10 ft (3.05 m)	5 lb (2.3 kg)	791828142125	€ 312
139-5012	12 ft (3.66 m)	5 lb (2.3 kg)	791828142149	€ 349
139-5014	14 ft (4.27 m)	6 lb (2.7 kg)	791828142163	€ 384
139-5016	16 ft (4.88 m)	7 lb (3.2 kg)	791828142187	€ 426
139-5018	18 ft (5.49 m)	7 lb (3.2 kg)	791828142200	€ 461
139-5020	20 ft (6.1 m)	7 lb (3.2 kg)	791828142224	€ 501
139-5022	22 ft (6.71 m)	7 lb (3.2 kg)	791828142248	€ 542
139-5024	24 ft (7.32 m)	8 lb (3.6 kg)	791828142262	€ 581
139-5026	26 ft (7.93 m)	8 lb (3.6 kg)	791828142286	€ 622
139-5028	28 ft (8.54 m)	9 lb (4.1 kg)	791828142309	€ 662
139-5030	30 ft (9.15 m)	9 lb (4.1 kg)	791828142323	€ 701
139-5032	32 ft (9.15 m)	10 lb (4.5 kg)	791828142347	€ 742
139-5034	34 ft (10.36 m)	10 lb (4.5 kg)	791828142361	€ 782
139-5036	36 ft (10.97 m)	10 lb (4.5 kg)	791828142385	€ 812
139-5038	38 ft (11.58 m)	10 lb (4.5 kg)	791828142408	€ 853
139-5040	40 ft (12.19 m)	10 lb (4.5 kg)	791828142422	€ 894

CLOUDS INTERNATIONAL B.V.



Replacement Bracket Assemblies

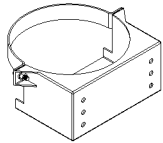
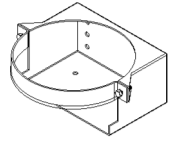
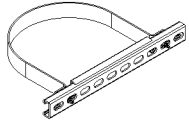
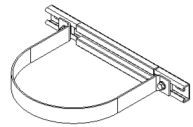

130-009

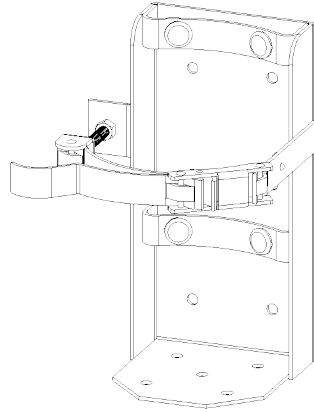

130-162

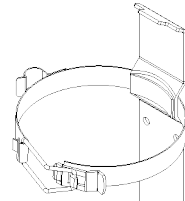

130-165

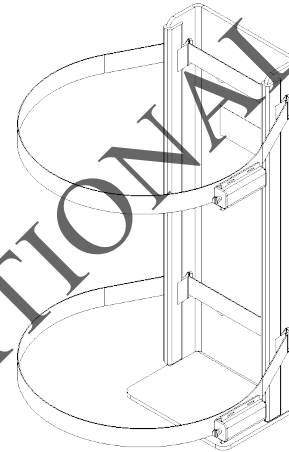

130-248

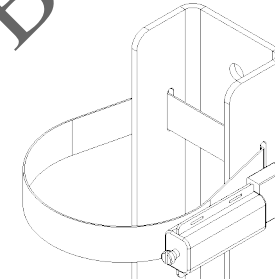

130-249

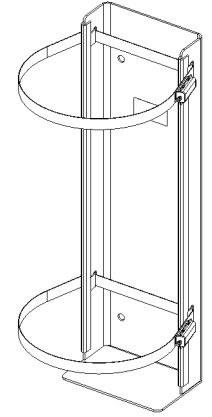

130-254

Part Number	Description	Model Size Compatibility		UPC Code	List Price- EUR
		HFC-227ea	FK-5-1-12		
130-249	Bracket Assembly, 2" x 7" with SAE 362 Clamps	FG/MG 25-50	NFG/NMG 25	791828361045	€ 70
130-826	Bracket Assembly, 2" x 7" with SAE 412 Clamps	FG/MG 51-75	N/A	791828361137	€ 78
130-775	Bracket Assembly, 2-3/4" x 11-3/4" with SAE 462 Clamps	FG/MG 76-100	NFG/NMG 26-75	791828361106	€ 110
130-805	Bracket Assembly, 2-3/4" x 11-3/4" with SAE 512 Clamps	FG/MG 101-125	NFG/NMG 76-100	791828361120	€ 111
130-250	Bracket Assembly, 4" x 12" with SAE 612 Clamps	FD/MD 126-225	NFD/NMD 101-200	791828361052	€ 119
130-251	Bracket Assembly, 4" x 12" with SAE 762 Clamps	FD/MD 226-350	NFD/NMD 201-300	791828361069	€ 123
130-252	Bracket Assembly, 6" x 15-5/8" with SAE 812 Clamps	FD/MD 351-500	NFD/NMD 301-400	791828361076	€ 141
130-253	Bracket Assembly, 6" x 20" with SAE 812 Clamps	FD/MD 501-600	NFD/NMD 401-525	791828361083	€ 179
130-254	Bracket Assembly, 6" x 20" with SAE 912 Clamps	FD/MD 601-800	NFD/NMD 526-675	791828361090	€ 182
130-777	Bracket Assembly, 6" x 24-1/2" with SAE 912 Clamps	FD/MD 801-1000	NFD/NMD 676-825	791828361113	€ 201
130-009	Bracket Assembly, 10" Diameter	FD/MD 1001-1500	NFD/NMD 826-1800	791828361007	€ 579



Portable Fire Extinguishers

Dry Chemical Portable Fire Extinguishers

Part Number	Description	List Price-EUR
130-550	Powder Fire Extinguisher 1 kg; MED	€ 56
130-551	Powder Fire Extinguisher 2 kg; MED	€ 72
130-552	Powder Fire Extinguisher 6 kg; MED	€ 102
130-553	Powder Fire Extinguisher 9 kg; MED	€ 157

Portable Extinguishers for Lithium Battery Fires

Part Number	Description	List Price-EUR
700-001	AVD Portable Fire Extinguisher 500ml (Aerosol)	€ 64
700-002	AVD Portable Fire Extinguisher 1 L	€ 144
700-003	AVD Portable Fire Extinguisher 2 L	€ 216
700-004	AVD Portable Fire Extinguisher 6 L	€ 537
700-005	AVD Portable Fire Extinguisher 9 L	€ 786
700-006	AVD Wheeled Fire Extinguisher 25 L	€ 5,858
700-007	AVD Wheeled Fire Extinguisher 50 L	€ 7,277

CLOUDS INTERNATIONAL B.V.



Fire Safety Kits & Blankets for Lithium Battery Fires

Lithium Battery Fire Safety Kits

Part Number	Description	List Price-EUR
700-008	FSK Small - Outer Dimension: 405 mm x 200 mm	€ 1,005
700-009	FSK Small & Aerosol	€ 1,059
700-010	FSK Small & 1 litre	€ 1,137
700-011	FSK Large - Outer Dimension: 535 mm x 250 mm	€ 1,750
700-012	FSK Large & 1 litre	€ 1,882
700-013	FSK Large & 2 litre	€ 1,954

Lithium Battery Fire Safety Covers

Part Number	Description	List Price-EUR
700-014	FRC no flame arrestors	€ 3,195

Lithium Battery Fire Blankets

Part Number	Description	List Price-EUR
700-015	Battery Fire Blanket Small - 2000 mm x 1700 mm	€ 842
700-016	Battery Fire Blanket Medium - 3300 mm x 2600 mm	€ 1,942
700-017	Battery Fire Blanket - 8000 mm x 6000 mm	€ 7,580

CLOUDS INTERNATIONAL B.V.



Electronics - Machinery Shutdown Restart Systems and Displays

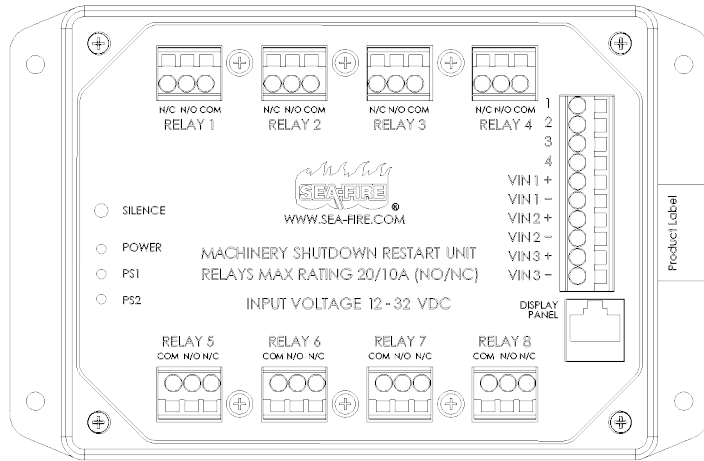

131-450/131-750

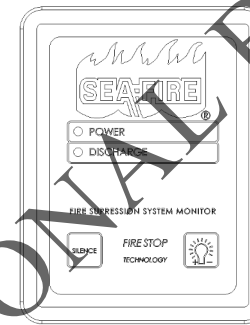

131-460

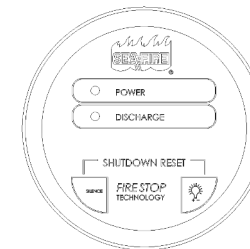
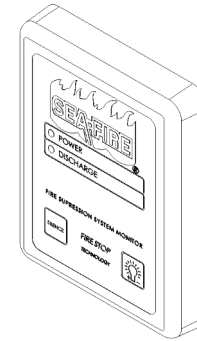

131-461

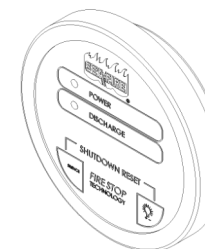

Machinery Shutdown Restart Unit (De-Energized)

Part #	Description	UPC Code	List Price - EUR
131-740	Engine Shutdown Control - 4 Circuit - 9-32 VDC	791828359875	€ 410
131-745	Engine Shutdown Control - 6 Circuit - 9-32 VDC	791828359882	€ 457
131-750	Engine Shutdown Control - 8 Circuit - 9-32 VDC	791828359899	€ 540

Machinery Shutdown Restart Unit (Energized)

Part #	Description	UPC Code	List Price - EUR
131-440	Engine Shutdown Control - 4 Circuit - 9-32 VDC	791828143238	€ 433
131-445	Engine Shutdown Control - 6 Circuit - 9-32 VDC	791828143245	€ 481
131-450	Engine Shutdown Control - 8 Circuit - 9-32 VDC	791828143252	€ 566

All Machinery Shutdown Systems require a display, sold separately

System Monitor and Engine Shutdown Control (MSRS Displays)

Part #	Description	UPC Code	List Price - EUR
131-460	Standard - Rectangular	791828143269	€ 185
131-461	Standard - Round	791828143276	€ 170
131-462	with High Temp Sensor - Rectangle	791828143283	€ 210
131-463	with High Temp Sensor - Round	791828143290	€ 197
131-464	with Aux Zone - Rectangle	791828143306	€ 210
131-465	with Aux Zone - Round	791828143313	€ 197
131-466	with Low Pressure - Rectangle	791828143320	€ 210
131-467	with Low Pressure - Round	791828143337	€ 197

All displays include a 3ft (1m) CAT 5 cable as standard, other lengths available as a special order.



Electronics - Legacy Engine Shutdown Restart System Displays

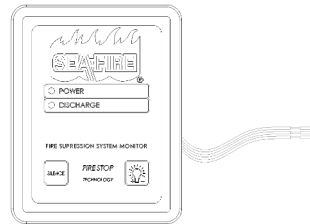

131-400

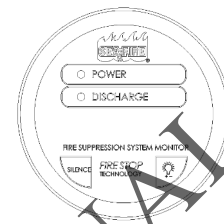

131-401

Legacy ESRS Display Series - With hardwire connector (Replacement displays for 131-2xx series)

Part #	Description	UPC Code	List Price - EUR
131-400	Fire Suppression System Supervisory Panel - Rectangle	791828143108	€ 188
131-401	Fire Suppression System Supervisory Panel - Round	791828143115	€ 188
131-410	Fire System Monitor with Engine Shutdown Control - Rectangle	791828143122	€ 188
131-411	Fire System Monitor with Engine Shutdown Control - Round	791828111435	€ 188
131-420	Fire System Monitor w/ E.S. Control and High Temp Zone - Rectangle	791828143139	€ 202
131-421	Fire System Monitor w/ E.S. Control and High Temp Zone - Round	791828143146	€ 202
131-425	Fire System Monitor w/ E.S. Control and Auxiliary Zone - Rectangle	791828143153	€ 202
131-426	Fire System Monitor w/ E.S. Control and Auxiliary Zone - Round	791828143160	€ 202
131-427	Fire System Monitor w/ E.S. Control w/ Low Press Zone - Rectangle	791828143177	€ 202
131-428	Fire System Monitor w/ E.S. Control w/ Low Press Zone - Round	791828143184	€ 202

Legacy Extender Cables

Part #	Description	UPC Code	List Price - EUR
124-066	ESEH 10-10' (3.05m) Extender Cable Display to Control Unit	791828142781	€ 192
124-067	ESEH 30-30' (9.15m) Extender Cable Display to Control Unit	791828142798	€ 192
124-068	ESEH 30-30' (9.15m) Extender Cable Double	791828142804	€ 192



Electronics - Detectors & Alarms

Marine Carbon Monoxide Alarms

Part Number	Description	List Price- EUR
124-468	Carbon Monoxide Alarm, Surface Mount, White, Battery Operated, EU	€ 64
124-469	Carbon Monoxide Alarm, Surface Mount, White, Battery Operated, US	€ 64

Smoke Detectors

Part Number	Description	List Price- EUR
131-101	Standalone Mini Smoke Detector	€ 35

Combination Smoke & CO Detectors - Stand-Alone (Battery Operated)

Part Number	Description	List Price- EUR
124-860	Combination Smoke and CO Alarm - UL Listed	€ 167
124-873	Combination Smoke and CO Alarm - CE Listed	€ 232

Heat Sensors

Part Number	Description	List Price- EUR
131-304	Heat Sensor Assembly with Enclosure - 160°F	€ 229
131-552	Heat Sensor Assembly with Enclosure - 135°F	€ 229

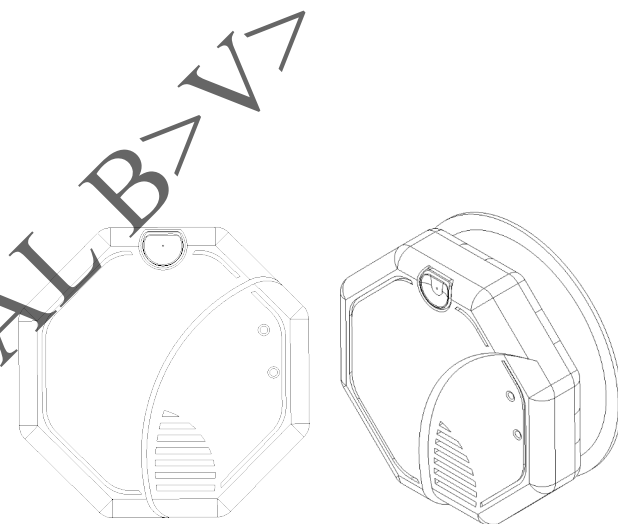

124-860



124-468/124-469

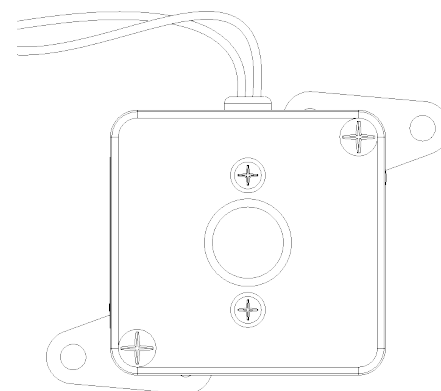

131-304



Electronics - Audio/Visual Devices

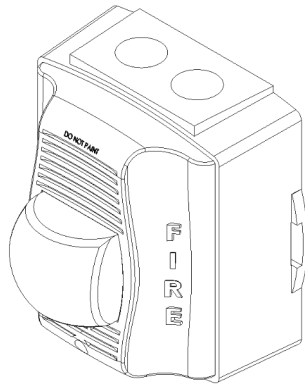

124-914

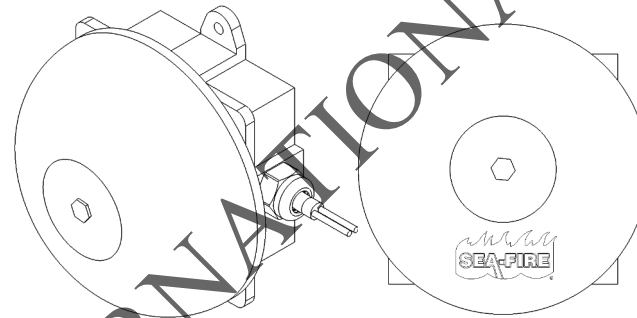
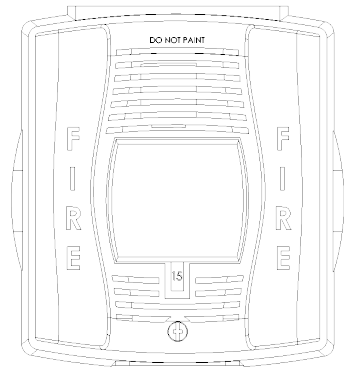

131-297



130-117

Audio/Visual Devices

Part Number	Description	UPC Code	List Price- EUR
124-914	Horn Strobe 12/24 V, Waterproof	791828111800	€ 230
124-969	Conventional weatherproof sounder strobe - Banshee Excel Lite IP66	791828359837	€ 278
124-1044	Banshee Excel Lite White / Amber Xenon IP66 Sounder / Beacon	791828359844	€ 278
131-297	Remote Bell 12 VDC with Waterproof Case	791828143047	€ 151
131-298	Remote Bell 24 VDC with Waterproof Case	791828143054	€ 151
124-236	6" Bell 24VDC IP23, 96 dB with Back Box	791828145218	€ 151
124-239	6" Bell 24VDC w/ Weatherproof Back Case IP33, 100dB and Back Box	791828145249	€ 98

Visual Devices

Part Number	Description	UPC Code	List Price- EUR
130-117	Indicator Light Kit with Panel - 12 VDC	791828145126	€ 38
130-118	Indicator Light Kit with Panel - 24 VDC	791828145133	€ 38



Manual Release Cable Accessories

Cable Discharge Adapters

Adapter Type	Cable	Part Number	List Price- EUR
Single Pull Station to Dual Cylinder Discharge Adapter (Adapter PN 131-1004)	None (Adapter Only)	131-1004	€ 142
	3 ft SMAC Cable	131-061	€ 173
Dual Pull Station to Single Cylinder Discharge Adapter (Adapter PN 131-1005)	None (Adapter Only)	131-1005	€ 142
	3 ft SMAC Cable with Fire Sleeve	131-057	€ 225
	1.5 ft SMAC Cable with Fire Sleeve	131-058	€ 192
	3 ft SMAC Cable	131-059	€ 173
	1.5 ft SMAC Cable	131-060	€ 167
	6 ft SMAC Cable	131-960	€ 189
	6 ft SMAC Cable with Fire Sleeve	131-961	€ 291

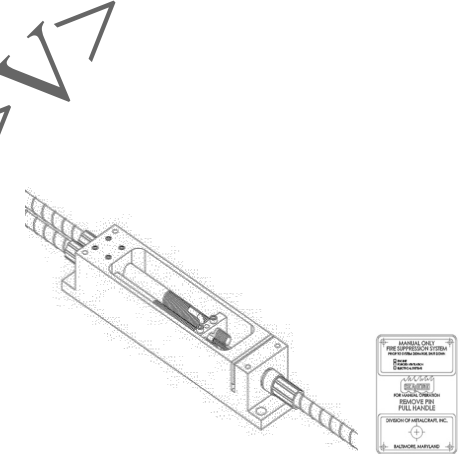

131-1004

Fire Resistant Sleeve

Part #	Length	Ship Weight	UPC Code	List Price- EUR
138-206	6 ft (1.83 m)	2.0 lb (1.0 kg)	791828328871	€ 88
138-208	8 ft (2.44 m)	2.0 lb (1.0 kg)	791828328895	€ 117
138-210	10 ft (3.05 m)	2.0 lb (1.0 kg)	791828328918	€ 144
138-212	12 ft (3.66 m)	2.0 lb (1.0 kg)	791828328932	€ 172
138-214	14 ft (4.27 m)	2.5 lb (1.5 kg)	791828328956	€ 201
138-216	16 ft (4.88 m)	2.5 lb (1.5 kg)	791828328970	€ 228
138-218	18 ft (5.49 m)	3.0 lb (1.5 kg)	791828328994	€ 255
138-220	20 ft (6.1 m)	3.0 lb (1.5 kg)	791828329014	€ 284
138-222	22 ft (6.71 m)	3.0 lb (1.5 kg)	791828329038	€ 311
138-224	24 ft (7.32 m)	3.0 lb (1.5 kg)	791828329052	€ 339
138-226	26 ft (7.93 m)	3.5 lb (2.0 kg)	791828329076	€ 368
138-228	28 ft (8.54 m)	3.5 lb (2.0 kg)	791828329090	€ 395
138-230	30 ft (9.15 m)	3.5 lb (2.0 kg)	791828329113	€ 423
138-232	32 ft (9.76m)	3.5 lb (2.0 kg)	791828329137	€ 450
138-234	34 ft (10.36m)	4.0 lb (2.5 kg)	791828329151	€ 478
138-236	36 ft (10.98 m)	4.0 lb (2.5 kg)	791828329175	€ 506
138-238	38 ft (11.58 m)	4.0 lb (2.5 kg)	791828329199	€ 534
138-240	40 ft (12.2 m)	4.0 lb (2.5 kg)	791828329212	€ 563

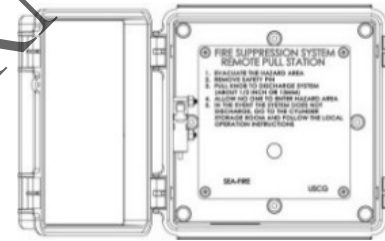

131-320

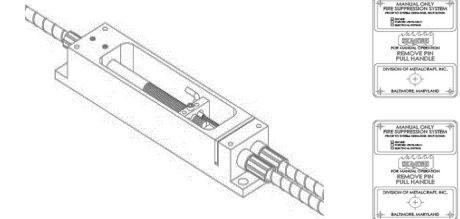

131-1005

Part Number	Description	Ship Weight	List Price- EUR
131-320	Fire Cabinet Pull Box - 6" x 6" x 3" - Includes limit switch on door. - Usable with 134-X### and 136-X### series cables - Does not include cable assembly or faceplate. Cable assembly must be ordered separately.	2 lb	€ 455



Fire Detection, Suppression and Integrated Solutions

Warranty Policy

Your Onboard Safe Choice

Sea-Fire Europe Ltd. Unit 2 Discovery Park Portfield Rd. Portsmouth UK PO3 5FN Tel: +44 (0)2392 679666

(1) YEAR LIMITED WARRANTY: H SERIES SYSTEMS / N SERIES SYSTEMS / M SERIES SYSTEMS / MN SERIES SYSTEMS / CABLE ASSEMBLY SERIES / ESRS SYSTEMS AND OTHER ELECTRONIC PRODUCTS

(2) YEAR LIMITED WARRANTY: NMG / NMD / NFG / NFD / MG / MD / FG / FD / FT / C / AT SERIES EXTINGUISHERS

(2-10)YEAR LIMITED WARRANTY: DRY CHEMICAL / AVD EXTINGUISHERS

We warranty to the original retail purchaser, all SEA-FIRE Marine products for the period as noted above against defective material and faulty workmanship. Any unit found to be defective during the warranty period will be repaired if possible, or replaced free of charge if classified non-refillable (according to product label) upon the buyer's prepaid return of the defective unit only after receipt of an official return authorization number. Proof of retail purchase required, otherwise date of manufacture on product label will apply. This warranty gives the buyer specific legal rights which may vary by state (or country.)

THE FOREGOING WARRANTY IS MADE IN LIEU OF ALL OTHER WARRANTIES WITH RESPECT TO THE PRODUCT, INCLUDING ANY IMPLIED WARRANTY OF MERCHANTABILITY OR FITNESS FOR A PARTICULAR PURPOSE. NO PERSON IS AUTHORIZED TO GIVE ANY OTHER WARRANTY, OR TO ASSUME FOR SEA-FIRE MARINE ANY OTHER LIABILITY IN CONNECTION WITH THE SALE OR INSTALLATION OF ITS PRODUCTS. REPLACEMENT OF THE PRODUCT WILL BE THE SOLE REMEDY WITH RESPECT TO ANY LOSS OR DAMAGE TO PROPERTY. BUYER IS NOT RELYING ON SELLER'S JUDGEMENT REGARDING BUYER'S PARTICULAR REQUIREMENTS AND BUYER HAS HAD AN OPPORTUNITY TO INSPECT THE PRODUCT TO BUYER'S SATISFACTION. UNAUTHORIZED SERVICE OF ANY KIND INVALIDATES ALL WARRANTY PROVISIONS.

CONDITIONS

All Sea-Fire products are tested after manufacture and shipped in perfect working order. Damage noted upon receipt of shipment should be addressed as a shipping claim, the filing of which is the sole responsibility of the consignee for which the total compensatory award will be limited to that appropriated by the carrier. Insured freight costs are the responsibility of the consignee. Missing component parts and damage noted upon installation are typically the result of mishandling during the installation process and will not qualify for warranty coverage. Incidents of accidental discharge are not indicative of product failure - heed product warnings to avoid injury and/or costs. Damaged products should be returned for repair or replacement under an official return authorization number, with associated costs assigned a purchase order number and shipping charges prepaid. Returned products must be received in resalable condition to qualify for credit, and are subject to a standard 20% (or greater based on circumstance) restocking fee. No returns will be processed without proper return authorization.

OUT OF WARRANTY REPLACEMENTS/RECHARGES

SEA-FIRE "NFG", "NMG", "FG", "MG" and "FT" Model Series cylinders comply with U.S. DOT Specification 39 and/or EU PED specifications. These systems are not refillable. The discharged cylinder will be replaced with a comparable SEA-FIRE extinguisher. Contact factory or authorized dealer for details.

SEA-FIRE "NFD", "NMD", "FD", "MD" and "C" Model Series cylinders comply with U.S. DOT Specification 4B360, 4BW500, 3AL1000, or 3AL1800 or EU TPED specifications which allows discharged cylinders to be refilled. The discharged extinguisher may be refilled if applicable or upon the buyer's prepaid return of the discharged system, provided it meets certain other standards for refill ability (i.e. - age and condition of cylinder). Contact factory or authorized dealer for details.

This warranty gives the buyer specific legal rights which may vary by state (or country).