

ARMSTRONG®

Swing Ladders

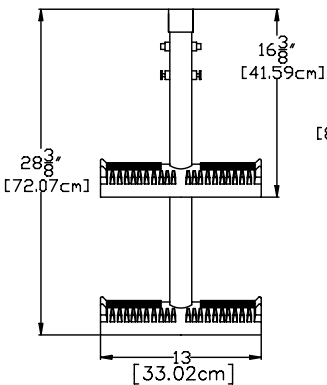

SL2-28

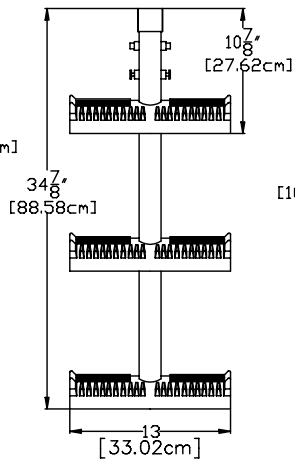

SL3-34

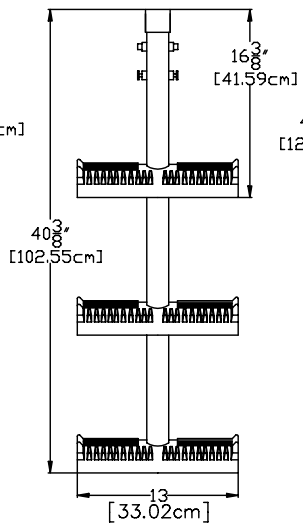

SL3-40

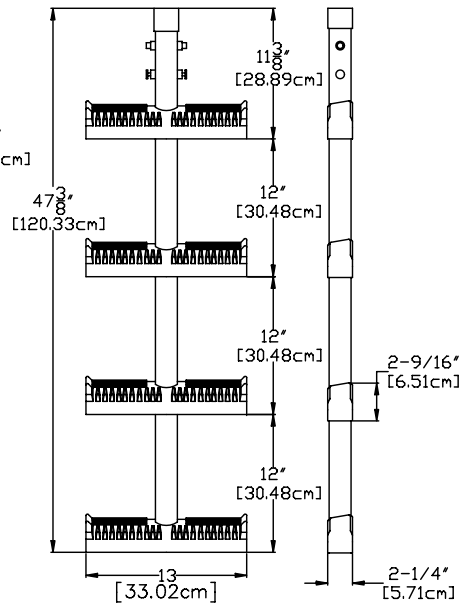

SL4-48

Side View

Ladder Mount Selection

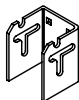

SM
Swing Mount

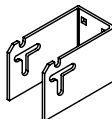

SM-XL
Swing Mount-Extra Long

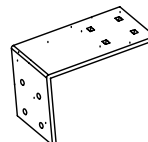

PSLM
Platform Swing Ladder Mount
for Adapting Swing Mount
to Platform Application

This drawing contains information proprietary to Armstrong Nautical Products any reproductions disclosure or use of this drawing is expressly prohibited except as Armstrong Nautical Products may otherwise authorize in writing. All designs and/or products are subject to change without notice.

ARMSTRONG NAUTICAL PRODUCTS
A Division of Vallery Industries, Inc.

(772) 286-7204 • (800) 226-7204
FAX (772) 286-1339
www.armstrongnautical.com
sales@armstrongnautical.com